



Falciola "seghezzo cantoniere" Small sickle
Acciaio forgiato Forged steel
Manico lungo Long handle

95632



Falciola "messorella erba" Small sickle
Acciaio forgiato Forged steel
Manico corto Short handle

95633



Falciola per rovi Small sickle
Modello pesante / Acciaio forgiato Heavy duty / Forged steel
Manico lungo Long handle

95634



Falciola per rovi Small sickle
Modello pesante / Acciaio forgiato Heavy duty / Forged steel
Manico corto con rampino Short handle with hook

95635



Falciolate - mod. TEMPO / Sickles

80765 N. 0

80766 N. 1

80767 N. 2

Seghezzi / Tooth sickles

80759 N. 2

80760 N. 3

Falciola "BACKA" "BACKA" sickles
Manico lungo Long handle

80770



falci e roncole sickles and billhook



papillon

Manarosso

Acciaio forgiato / molato
Manico cuoio

"Manarosso" Billhook
Forged steel
Leather handle

95647



8 000071 956475



papillon

Roncola macete

Acciaio forgiato / Lama lucida
Manico legno
Con fodero

Billhook machete
Forged steel / Shiny blade
Leather handle
With cover

95649



8 000071 956499



papillon

Roncola "tipo classico"

Acciaio forgiato / molato
Manico cuoio

Billhook
Forged steel
Leather handle

95648



8 000071 956482



papillon

Pennato

Acciaio forgiato / molato
Manico cuoio
Con fodero

Twin edge billhook
Forged steel
Leather handle
With cover

95650



8 000071 956505



papillon

Roncolino

Acciaio forgiato / molato
Manico legno rosso

Small Billhook
Forged steel
Red Wood handle

95654



8 000071 956543



Roncola a mezzaluna

Acciaio forgiato / molato
Manico tubolare

Billhook Half-moon shape
Forged steel
Tubular handle

95651



Roncola a pertica / Long arm slasher

80775

N. 0



Ronchina per orto / Billhook

80777

22 cm



Gancio porta roncola

Acciaio zincato

Hook for billhook
Forged steel

95653



sickles **falci**



Falce per fieno

Acciaio forgiato
Lunghezza 65 cm

Sickle for hay
Forged steel
Length 65 cm

95631



Manico per falce

Tubolare in acciaio
Ø 3,5 cm

Handle for sickle
Steel tubular frame
Length 65 cm

95639





falci sickles



Falcioni *DUE OTTOMANI*

Modello senza barba, punta chiodo - Strettissime

80701 lunghezza 55 cm

80702 lunghezza 60 cm

80703 lunghezza 65 cm



Manico per falci

Tubolare in acciaio

Sickles handle

Steel tubular frame

50790



Cote smeriglio / Whetstone

95637



Porta cote in plastica / Whetstone holder

95638



Anello ferma falce

Acciaio

Ring for sickle's handle
Iron

95636



Accessori per falci / Sickles accessories

• 80698 Pietre coti smeriglio / Emery stones

50795 Porta coti in plastica / Plastic support

portaforbici shear holder



Portaforbici in nylon / Nylon shear holder

• 93776



Portaforbici in pelle / Leather shear holder

• 93778





mod. CLASSIC LIGHT

Leggera e maneggevole
Taglio passante
Lama acciaio SK5
Capacità di taglio su legno verde 18 mm
Manici alluminio
Lunghezza 210 mm

Lightweight easy to use
By-pass cut
SK5 steel blade
Cutting capacity 18 mm
Aluminium handles
Length 210 mm

• 96798



easy/cut



mod. CLASSIC

Taglio passante
Lama acciaio SK5
Capacità di taglio su legno verde 20 mm
Manici alluminio
Due posizioni di taglio
Lunghezza 215 mm

By-pass cut
SK5 steel blade
Cutting capacity 20 mm
Aluminium handles
Two position lock
Length 215 mm

• 93886

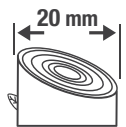

mod. ERGONOMIC

Testa di taglio inclinata
Taglio passante
Lama acciaio SK5
Capacità di taglio su legno verde 20 mm
Manici alluminio
Due posizioni di taglio
Lunghezza 215 mm

Tilted cutting head
By-pass cut
SK5 steel blade
Cutting capacity 20 mm
Aluminium handles
Two position lock
Length 215 mm

• 93887

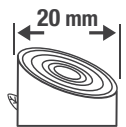

mod. PREMIUM

Taglio passante
Corpo in alluminio
Sbloccaggio lama mediante pressione sull'impugnatura
Lama acciaio Easycut
Capacità di taglio su legno verde 20 mm
Impugnatura antiscivolo
Con ammortizzatore
Lunghezza 205 mm

By-pass cut
Aluminium body
Unclamping the lock by handles pressure
Easycut steel blade
Cutting capacity 20 mm
Antislip PVC grip handles
With damper
Length 205 mm

• 92925

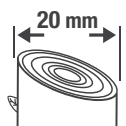

easy/cut



forbici per potatura professionali professional pruning shears



KANZAWA mod. KS-4

Taglio passante
Lama acciaio temprato cromato
Capacità di taglio su legno verde 18 mm
Con ammortizzatore e tagliafilii
Lunghezza 220 mm

By-pass cut
Chrome-tempered blade
Cutting capacity 18 mm
With damper and wire cutter
Length 220 mm

• 87399



Lama acciaio / Blade

• 87600



Molla universale / Spring

• 87602



mod. STRONG

Taglio passante
Corpo acciaio forgiato
Capacità di taglio su legno verde 18 mm
Impugnatura in spugna antiscivolo
Lunghezza 205 mm

By-pass cut
Drop forged constructions
Cutting capacity 18 mm
Foam coated non-slip handles
Length 205 mm

• 89442



mod. PROCUT

Taglio passante
Acciaio al carbonio forgiato a caldo
fermo di chiusura in cuoio
Capacità di taglio su legno verde 20 mm
Lunghezza 200 mm

By-pass cut
Drop forged high carbon steel
Leather closure
Cutting capacity 20 mm
Length 200 mm

• 98236

180 mm



• 55619

200 mm



mod. CRICUT

Taglio a battuta a cricco - Ratchet system
Lama Easycut
Capacità di taglio su legno verde 22 mm
Impugnatura inferiore avvolgente
Lunghezza 210 mm
Peso 260 gr

Anvil ratchet - Ratchet system
Easycut coated blade
Cutting capacity 22 mm
Looping lower handle
Length 210 mm
Weight 260 gr

• 87773



Set lame Easycut / Easycut blades set

• 88330





mod. DUALCUT

Doppio taglio	Double edge
Acciaio al cromo-vanadio forgiato a caldo	Drop forged chrome-vanadium steel
Capacità di taglio 25 mm	Cutting capacity 25 mm
Manici plastificati antiscivolo	Anti-slip plastic handles
Fermo di sicurezza in metallo	Metal safety latch
Lunghezza 200 mm	Length 200 mm

• 55618



pruning shears **forbici per potatura**



mod. BABY

Manici plastificati	Plastic handles
Lunghezza 165 mm	Length 165 mm

• 81695



mod. BASIC

Taglio passante	By-pass cut
Alluminio pressofuso	Aluminium body
Lama acciaio carbonio	Carbon steel blade
Lunghezza 200 mm	Length 200 mm

• 93885



Cogliuva	Grape shear
Manici plastificati	Plastic handles
Lunghezza 175 mm	Length 175 mm

• 81694



Cogliuva	Grape shear
Lame in acciaio speciale	Special steel blades
finitura brunita	Burnish finish
Chiusura a nastro	Belt closure
Lunghezza 192 mm	Length 192 mm

• 88332





forbici per erba grass shear



Forbice per erba professionale

Lame acciaio inossidabile
Lame regolabili su 6 posizioni
Manici gomma antiscivolo

Professional grass shear
Inox steel blade
6 positions
Rubber antigrip handles

• 87286



easy/cut



Lama Easycut
Lame regolabili 360°
Manici ammortizzati

Easycut blade
Free section
Handles with damper

• 87285



cesoie - raccoglifrutta tree pruner - fruit picker



Cesoia raccoglifrutta

Manico prolungato in alluminio girevole -
Lunghezza 2 metri

Fruit picker
Swivel long arm aluminium tube
Length 2 m

• 80696



Raccoglifrutta
Senza manico

Fruit picker
Without handle

• 80693





Cesoia per potatura

2 impugnature di taglio
Lama Easycut / Lama acciaio SK-5
Manico tubolare in alluminio
Taglio inclinato a 180° - 6 regolazioni
Capacità di taglio su legno verde 20 mm
Blocco di sicurezza
Lunghezza 2 metri

Tree pruner
2 Cutting grip for pruning
Easycut blade / Steel blade SK-5
Long arm aluminium tube
Cutting tilted to 180° - 6 settings
Cutting capacity on green material 20 mm
Safety lock
Length 2 m

• 98769



Cesoia per potatura

Lama Easycut / Lama acciaio SK-5
Manico tubolare in alluminio
Capacità di taglio su legno verde 15 mm
Lunghezza 2 metri

Tree pruner
Easycut blade / Steel blade SK-5
Long arm aluminium tube
Cutting capacity on green material 15 mm
Length 2 m

• 93906

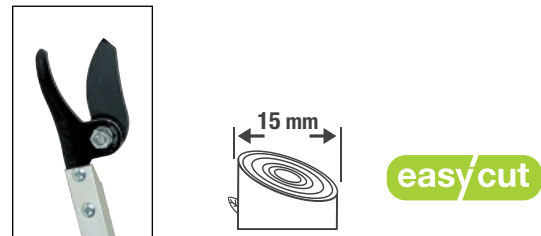

Cesoia potatura - raccogli frutta

Lama Easycut / Lama acciaio SK-5
Manico in alluminio telescopico a 6 posizioni da 190 cm a 309 cm
Capacità di taglio su legno verde 12 mm
Testa regolabile in 3 posizioni
Con gancio

Tree pruner - Fruit picker
Easycut blade / Steel blade SK-5
Telescopic aluminium handle
6 sections: 190-309 cm
Cutting capacity on green material 12 mm
Adjustable head 3 positions
With hook

• 97755





tagliarami telescopici telescopic loppers



Taglio a battuta a cricco
Lama Easycut in acciaio SK5
Manici telescopici ovali in alluminio con pulsante di blocco
Impugnatura in bicomponente ergonomica
Lunghezza 700÷1060 mm

Hook anvil ratchet
Easycut steel SK5 blade
Telescopic aluminium handles with button stop
Ergonomic bicomponent handle
Length 700÷1060 mm

• 90979

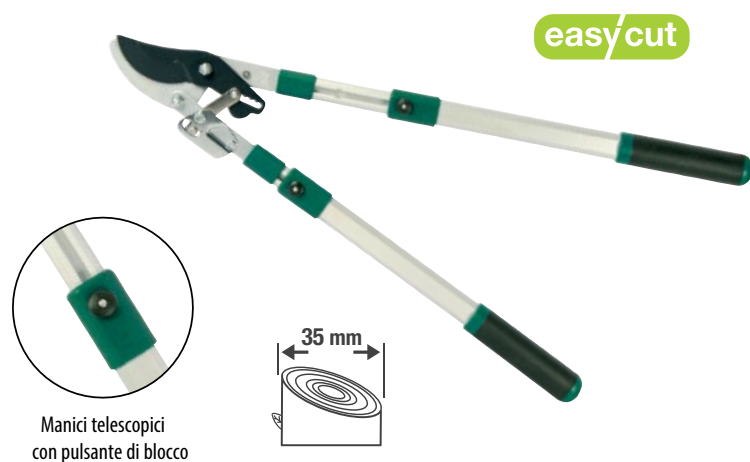

Taglio passante a cricco
Lama Easycut
Manici telescopici ovali in alluminio con pulsante di blocco
Impugnatura in bicomponente ergonomica
Lunghezza 700÷1015 mm

By-pass ratchet
Easycut blade
Telescopic aluminium handles with lever stop
Ergonomic bicomponent handle
Length 700÷1015 mm

• 89597

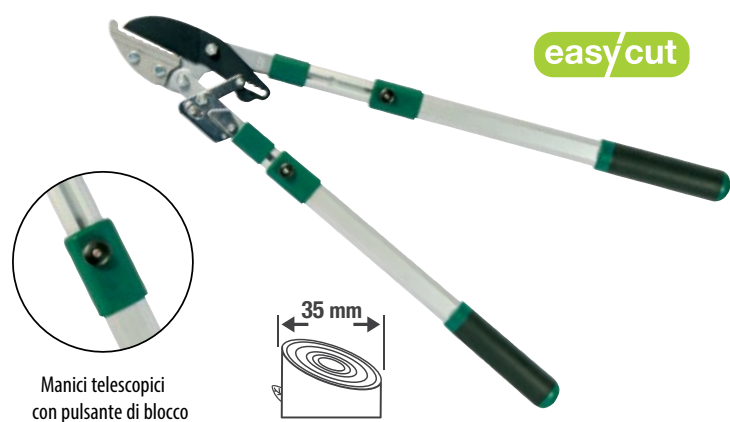

Taglio a battuta a cricco
Lama Easycut
Manici telescopici ovali in alluminio con pulsante di blocco
Impugnatura in bicomponente ergonomica
Lunghezza 700÷1015 mm

Hook anvil ratchet
Easycut blade
Telescopic aluminium handles with lever stop
Ergonomic bicomponent handle
Length 700÷1015 mm

• 89596





ENERGY SAVING

Lama Easycut
Taglio passante a cricco
Manici alluminio
Impugnatura in bicomponente ergonomica
Lunghezza 760 mm

ENERGY SAVING

Easycut blade
By-pass ratchet
Aluminium handles
Ergonomic bicomponent handle
Length 760 mm

• 90147

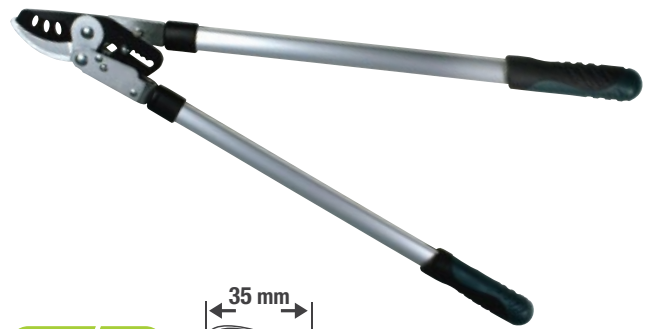

easy/cut

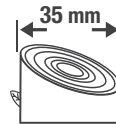

ENERGY SAVING

Lama Easycut
Taglio battuta a cricco
Manici alluminio
Impugnatura in bicomponente ergonomica
Lunghezza 760 mm

ENERGY SAVING

Easycut blade
Anvil ratchet
Aluminium handles
Ergonomic bicomponent handle
Length 760 mm

• 90148

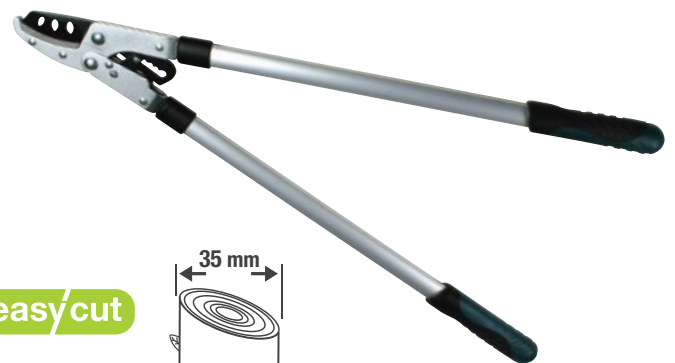

easy/cut

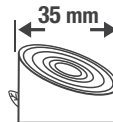

Lama Easycut
Taglio passante demoltiplicato
Manici tubolari acciaio
Lunghezza 750 mm

Easycut blade
By-pass cut
Tubular steel handles
Length 750 mm

• 83405

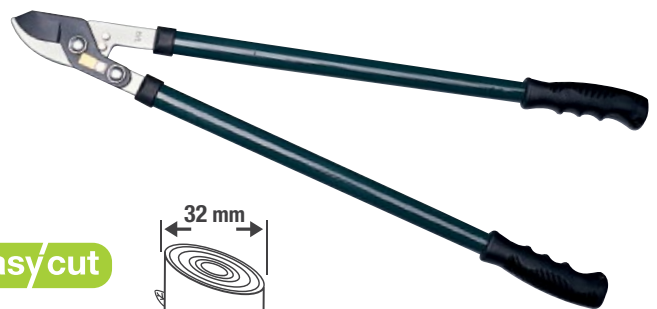

easy/cut

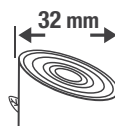

Lama Easycut
Taglio a battuta demoltiplicato
Manici tubolari acciaio
Lunghezza 750 mm

Easycut blade
Anvil lever
Tubular steel handles
Length 750 mm

• 83406

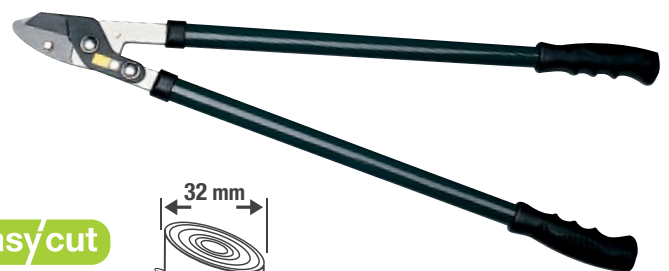

easy/cut

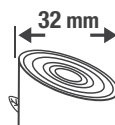



forbici per siepe hedges shears



easy/cut



Manici telescopici
con pulsante di blocco



mod. TELESCOPICO

Lame ondulate Easycut
Lunghezza lame 230 mm
Manici ovali telescopici in alluminio
con pulsante di blocco
Impugnatura in bicomponente
ergonomica
Lunghezza 705÷860 mm

Easycut wavy blades
Blades length 230 mm
Telescopic aluminium handles with
lever stop
Ergonomic bicomponent handle
Length 705÷860 mm

• 89595



8 000071 895958



easy/cut



mod. FISSO

Lame ondulate Easycut
Lunghezza lame 225 mm
Manici tubolari in alluminio con
ammortizzatore
Impugnatura in bicomponente
ergonomica

Easycut wavy blades
Blade length 225 mm
Tubular aluminium handles with
damper
Ergonomic bicomponent handle

• 86167



8 000071 861670



Lunghezza lame 210 mm
Con ammortizzatore
Manici in legno

Blade length 210 mm
With damper
Wooden handles

• 85995



8 000071 859950



Manico pieghevole Con pulsante di bloccaggio lama Lama acciaio SK5 - Cromata Dentatura speciale rettificata su 3 angoli, affilata, temprata Impugnatura bicomponente ergonomica e antiscivolo	Folding saw With push button locking blade Steel blade SK5 - Chrome Special grind teeth, sharpened and tempered Bicomponent ergonomic handle and no slip grip
---	--

• 80692	lama / blade 170 mm	
----------------	---------------------	--

• 85947	lama / blade 220 mm	
----------------	---------------------	--



Manico pieghevole Con pulsante di bloccaggio lama Lama curva acciaio SK5 Triplice affilatura e denti temprati Impugnatura bicomponente ergonomica e antiscivolo	Folding saw With push button locking blade Curve steel blade SK5 Triple edge and impulse hardened teeth TPR handle ergonomic and no slip grip
--	---

• 94965	lama / blade 180 mm	
----------------	---------------------	--



Lama curva in acciaio SK5 - Cromata Dentatura speciale rettificata su 3 angoli, affilata, temprata Manico tubolare acciaio ad ombrello	Curve steel blade SK5 - Chrome Special grind teeth, sharpened and tempered Steel tubular umbrella handle
---	--

• 88361	lama / blade 350 mm	
----------------	---------------------	--



Lama dritta acciaio SK5 - Cromata Dentatura speciale rettificata su 3 angoli, affilata, temprata Impugnatura bicomponente ergonomica e antiscivolo Con fodero	Steel blade SK5 - Chrome Special grind teeth, sharpened and tempered Bicomponent ergonomic handle and no slip grip With scabbard
--	--

• 85698	lama / blade 250 mm	
----------------	---------------------	--

• 84527	lama / blade 300 mm	
----------------	---------------------	--





segacci potatura lama fissa pruning saws



Lama dritta acciaio SK5
 Triplice affilatura e denti temprati
 Impugnatura bicomponente ergonomica e antiscivolo
 Con fodero

Steel blade SK5
 Triple edge and impulse hardened teeth
 TPR handle ergonomic and no slip grip
 With scabbard

• 94966

lama / blade 300 mm



Lama curva acciaio SK5
 Triplice affilatura e denti temprati
 Impugnatura bicomponente ergonomica e antiscivolo
 Con fodero

Steel blade SK5
 Triple edge and impulse hardened teeth
 TPR handle ergonomic and no slip grip
 With scabbard

• 94967

lama / blade 330 mm



Lama curva in acciaio SK5 - Cromata
 Dentatura speciale rettificata su 3 angoli, affilata, temprata
 Impugnatura bicomponente ergonomica e antiscivolo

Curve steel blade SK5 - Chrome
 Special grind teeth, sharpened and tempered
 Bicomponent ergonomic handle and no slip grip

• 88337

lama / blade 350 mm



Lama curva in acciaio SK5 - Cromata
 Dentatura speciale rettificata su 3 angoli, affilata, temprata
 Impugnatura tubolare adatta anche per prolunga a pertica
 Con dispositivo tagliente scortecciatore

Curve steel blade SK5 - Chrome
 Special grind teeth, sharpened and tempered
 Steel tubular handle suitable for perch extension
 With peeling knife

• 88338

lama / blade 400 mm





Taglio semplice - metallo verniciato
Con lama temprata

Single cut - painted steel
Hardened steel blade

• 83657



Svettatoio telescopico
Manico alluminio estensibile
Con lama temprata
Lunghezza max 2,50 metri

Telescopic tree pruner
Tubular aluminium handle
Hardened steel blade
Length max 2,50 m

• 80697

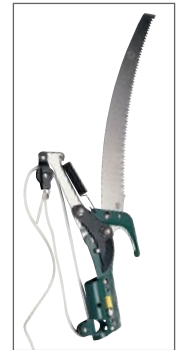

Attacco portalama girevole
Telaio tubolare con leva di tensione
Impugnatura paracolpi
Con 2 lame legno/metalli 300 mm

Revolving bow saw
Tubular frame with tension lever
Buffer handle
With 2 blade wood/metal 300 mm

91643



Attacco portalama girevole
Telaio tubolare con leva di tensione
Con lama 533 mm

Revolving bow saw
Tubular frame with tension lever
With blade 533 mm

91641





segoncini bow saws



Attacco portalama fisso Revolving bow saw
 Telaio tubolare con leva di tensione Tubular frame with tension lever

91644	610 mm	8 000071 916448
91646	812 mm	8 000071 916462
91647	914 mm	8 000071 916479

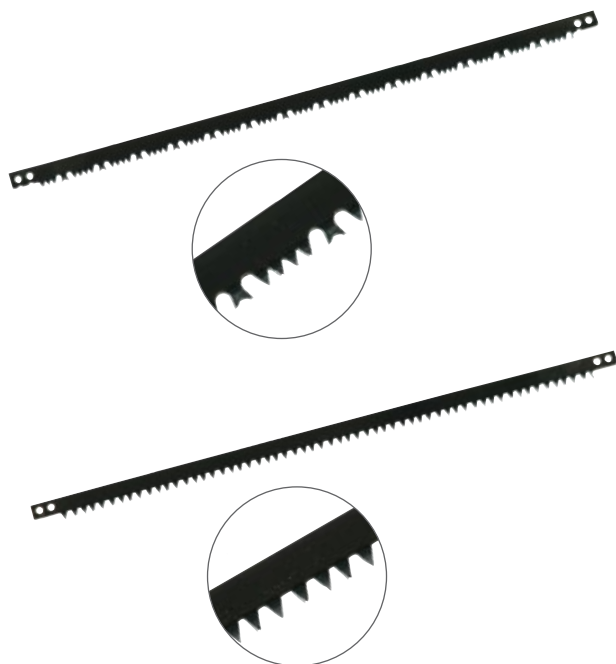

Lama dentatura castello Serration castle blade
 Per taglio legna verde Cutting green wood

91675	300 mm	8 000071 916752
91648	533 mm	8 000071 916486
91649	610 mm	8 000071 916493
91650	762 mm	8 000071 916509
91651	812 mm	8 000071 916516
91652	914 mm	8 000071 916523

Lama dentatura triangolo Triangular castle blade
 Per taglio legna secca Cutting dry wood

91653	533 mm	8 000071 916530
--------------	--------	-----------------

piccozzini hatchets



Piccozzino Hatchet
 Acciaio forgiato Forged steel
 Manico legno verniciato Wooden handle

95643	400 gr / 400 mm	8 000071 956437
--------------	-----------------	-----------------



Piccozzini Hatchets
 Acciaio temprato Forged steel
 Manico legno sagomato e verniciato Wooden handle

• 80189	600 gr / 360 mm	8 000071 801898
----------------	-----------------	-----------------



hatchets **piccozzini**



MAURER

Piccozzini

Acciaio temprato
Manico fibra vetro

Hatchets
Forged steel
Fibreglass handle

• **86618** 600 gr / 360 mm 8 000071 866187

• **86619** 800 gr / 380 mm 8 000071 866194



MAURER PLUS

Piccozzino

Corpo acciaio forgiato e verniciato
Manico ergonomico antiscivolo in
fibra di vetro ricoperto in PP+TPR

Hatchets
Forged steel body
Ergonomic antislip handle fiberglass
covered on PP+TPR

• **94280** 600 gr / 350 mm 8 000071 942805

axes **scuri**

papillon

Scure "Yankee"

Acciaio forgiato molato e verniciato
Manico legno sagomato e verniciato

Axe "Yankee"
Forged steel
Wooden handle

95645 1900 gr / 900 mm 8 000071 956451



MAURER

Scure

Acciaio temprato
Manico legno verniciato

Axes
Hardened steel
Wooden handle

• **80187** 1500 gr / 800 mm 8 000071 801874



MAURER

Scure

Acciaio temprato
Manico fibra vetro

Axes
Hardened steel
Fibreglass handle

• **86622** 1500 gr / 800 mm 8 000071 866224





mazze spaccalegna splitting axes



Mazza spaccalegna

Acciaio forgiato molato e verniciato
Collare di sicurezza
Manico legno verniciato

Splitting axe
Forged steel
Safety collar
Wooden handle

95644

2500 gr / 900 mm



Mazza spaccalegna

Corpo acciaio forgiato e verniciato
Manico ergonomico antiscivolo in fibra di vetro ricoperto in PP+TPR
Collare di sicurezza

Hatchets
Forged steel body
Ergonomic antislip handle fiberglass covered on PP+TPR
Safety collar

• 94277

2720 gr / 900 mm



• 94278

3630 gr / 900 mm



Mazza spaccalegna

Con arpione
Corpo acciaio forgiato e verniciato
Manico ergonomico antiscivolo in fibra di vetro ricoperto in PP+TPR
Collare di sicurezza

Hatchets
With harpoon
Forged steel body
Ergonomic antislip handle fiberglass covered on PP+TPR
Safety collar

• 94279

3000 gr / 900 mm



picconi pickaxes



Zappa scure

Acciaio forgiato / molato
Occhio ovale
Collare di sicurezza
Manico legno verniciato

Pickaxe Garden style
Forged steel
Oval connection
Safety collar
Wooden handle

95642

900 mm





Coltello innesto pieghevole

Lama acciaio inox
Lama a filo diritto
Manico legno
Lunghezza totale 17,6 cm

Grafting budding knife foldable
Stainless steel blade
Wooden handle
Total length 17,6 cm

• 93741



Coltello "Boscaiolo"

Con spazzolino
Lama acciaio inox
Lama curva
Manico legno
Lunghezza totale 18 cm

Folding pocket knife
With brush
Stainless steel blade
With nail groove
Wooden handle
Total length 18 cm

• 94772

